



CISA®

Cam action
door closers



For some building users a self-closing fire door can become a barrier to access

The principal objective of a door closer is, not surprisingly, to close a door and in the case of unlatched fire doors in a corridor, to keep the doors closed in the event of a fire. No wonder then that the ease with which such a door can be pulled open can be severely compromised by this opposing force. So much so in fact that many users, including the elderly, small children and those with various physical disabilities, find the door can become a barrier to them accessing the building and its facilities, or at least it becomes an obstacle to be overcome.



The Equalities Act - disability legislation

Legislation aimed at providing universal accessibility of buildings requires service providers to make “reasonable adjustments to the physical features of their premises to overcome barriers to access”.

Approved Doc M of the Building Regulations and BS 8300 both provide guidance in establishing recommended maximum opening forces for door controls to assist less able users (refer to page 23 for further information).

High efficiency CISA closers which are capable of meeting the required levels of opening and closing forces are marked with the “Wheelchair Symbol” but accurate installation, hinge friction, door seals and variable air pressure can all have a bearing on the opening resistance of the final doorset.

For doors which must also meet the stringent closing force requirements for fire door applications, it may be more appropriate to use electromagnetic hold open or swing free closers or a powered opening solution.

Easy Opening, Reliable Closing

In contrast to a conventional rack and pinion door closer in a slide channel application, the linear cam action principle of the CISA Easy Opening Series of door closers is extremely efficient. The initial opening force decreases very rapidly as the door opens allowing, in particular, children and the elderly to overcome the closing power without any problem.

During testing, the CISA cam action closers produced the following torque graph which illustrates the respective opening and closing forces throughout the opening and closing cycle of the door. The measurements were taken with the closer set at power size 3 and show the opening forces well within the requirements of Approved Doc M and BS8300.

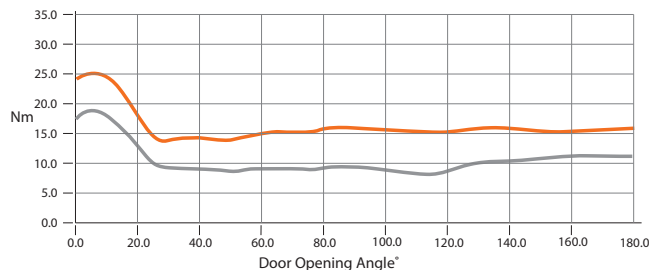

Force Profile

Closer D7200 set to EN 3 Power setting

- Opening Moment
- Closing Moment

A model to suit all applications and budgets



The CISA D7200 Series, a high performance, function rich series of surface mounted overhead door closers with adjustable power EN 2 - 5 and electromagnetic hold-open variants.



The CISA D6200 Series provides many of the features of the CISA D7200 but in a slimline and cost effective package. Available in simple trimplate option or with an all-over cover variant.



The CISA D8200 Series offers the full benefits of the CISA cam action in a fully concealed format, offering exceptional performance and aesthetics.

CISA D7200 Series - Offering the benefits of easy opening and reliable closing

The CISA D7200 Series is a precision manufactured cam-action, slide channel door closer, in a compact, overhead, surface fixed unit. Providing exceptional ease of use by reducing the resistance encountered when opening the door, the CISA D7200 Series bridges the gap between the requirements for fire and smoke control and ease of operation required for accessibility.



The CISA D7200 Series is CE marked to EN1154 (EN1155 for electronic variants) and fire tested to EN1634 on timber doors to achieve a 2 hour fire rating, and 1 hour for metal doors.



AD0264 (EN 1154)



CISA D7200 with standard A-Line cover



Features & Benefits

- A** CISA D7200 Series cast iron door closers have a naturally high graphite content that lubricates inner components with every use, resulting in high levels of durability and long life performance.
- B** High performance cam action technology is extremely efficient, allowing the closer to be set to provide reliable closing power for fire door applications yet still be easy to open.
- C** Full complement bearings provide increased bearing load for efficient operation and improved reliability.
- D** FAST PowerAdjust dial feature allows installers to see the current power setting and adjust the spring power to suit door conditions.
- E** Coil springs manufactured in silicon chrome alloy steel for superior strength and reliability.
- F** High quality hydraulic fluid with built-in temperature compensation ensures reliable performance in temperatures from -15 °C to +40 °C without the need for seasonal adjustments.
- G** Accufit mounting plate, with universal hole pattern incorporates dowel fixings to position the closer body and a spring clip mechanism for a quick and positive fixing of the body cover.
- H** Distinctive all-over metal ‘snap-on’ cover in a smooth, contemporary design; secured by simple, unobtrusive spring-clips to conceal the main door closer fixings (A-line cover only).
- I** Optional ‘Softline’ cover design (see image above) to suite with most other CISA closers.
- J** Co-ordinated track design with concealed fixings, provides smooth operation of the opening and closing cycle.

Accufit self adhesive template, together with easy-to-read instructions assist quick and easy installation.

A wide range of adjustable functions for easy adaptation to specific door applications.

CISA D7200 Series door controls are packed complete - reducing the possibility of lost or missing parts.
- 0** See standard control options and adjustments 0 - 4 overleaf, adjustable by Hex socket key.
- 5** Optional mechanical hold-open facility or electromagnetic hold-open option available.

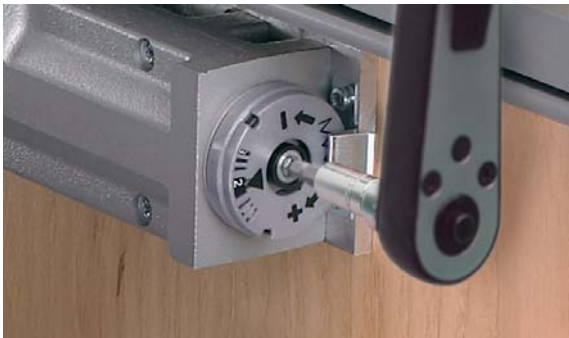

Mechanical hold open unit

The hold open unit is achieved by use of a conversion kit which can be installed into the slide track of the mechanical closers in place of the standard pivot block. It enables doors to be securely held in the open position at the required pre-set angle (adjustable on installation from 80° to 120° depending on model and the mounting application).

The hold open facility can be easily switched on/off and the force required to release the hold open action can be adjusted to suit the weight of door.

Conversion Kit reference 1.07210.00.0

Please note, mechanical hold open is not permitted on fire door applications.

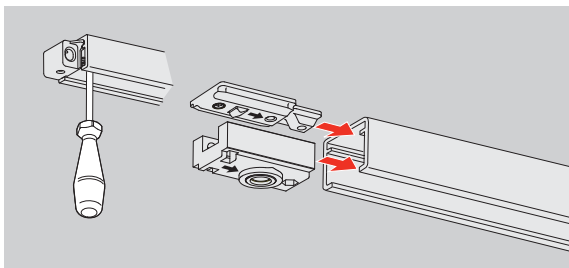

Closer adjustments

Adjustable closing power

The innovative 'FAST PowerAdjust' mechanism provides a visual guide on the EN power level at which the closer has been adjusted.

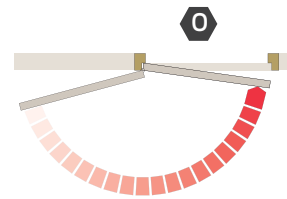

Adjustable closing speed

Adjustable from 120° opening through to the final 7°.

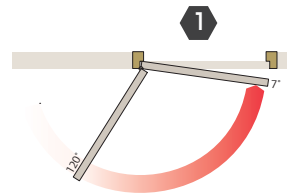

Adjustable latch action

The speed of closing in the last 7° can be adjusted to overcome seals and latches.

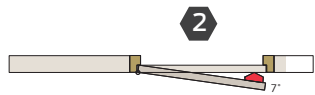

Adjustable delayed action

The closer can be set to close more slowly to give people extra time to pass through the doorway. Adjustable between 70° and 120°.

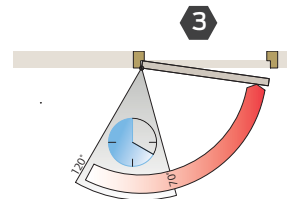

Adjustable backcheck

To prevent damage to the door, hardware and adjacent walls, caused by the door being flung open or caught by a gust of wind.

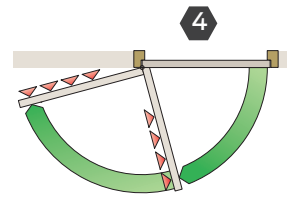

Adjustable hold-open

Mechanical and electromagnetic hold-open variants are available to hold the door in the open position.

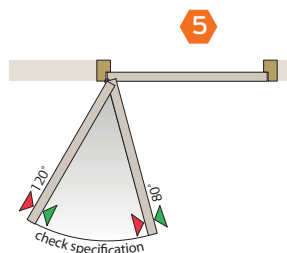

Mechanical hold-open - 80° - 120°

Electromagnetic hold-open - 80° - 120°

Door Mount Pull Side

Door Mount Push Side

Door Mount Push Side (Upward Fix)

Above angles are subject to hinge projection and surrounding structures.

CISA Series D7200 - Installation

Installation made quick and easy

The efficiency and durability of an overhead door control is greatly improved by accurate installation. The CISA D7200 Series has a number of features aimed at simplifying the installation process, including self adhesive Accufit template and mounting bracket. With the addition of the 'FAST' power adjustment dial and snap-on covers the process is quick and easy too.

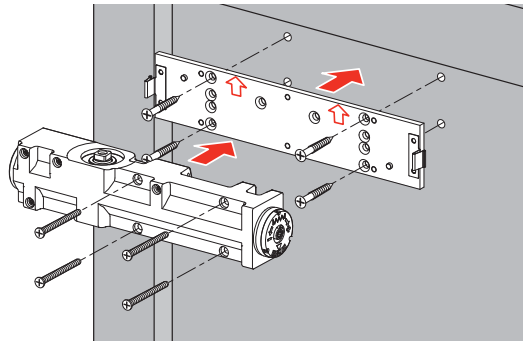

CISA Series D7200 - Installation options

CISA D7200

Pull Side/Door Mounted

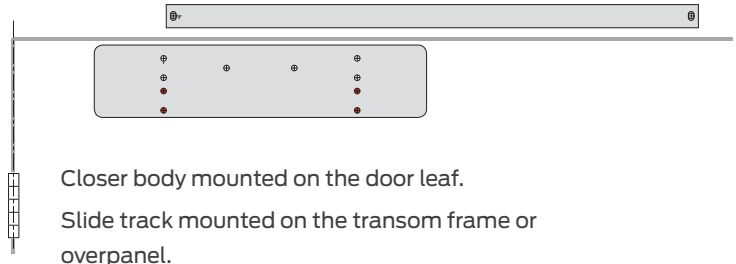
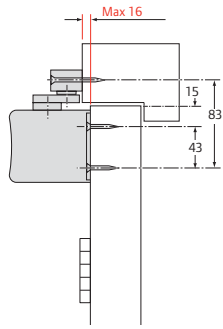

Closer body mounted on the door leaf.
 Slide track mounted on the transom frame or overpanel.
 Door opening angle is 180° max.

CISA D7200

Push Side/Transom Mounted

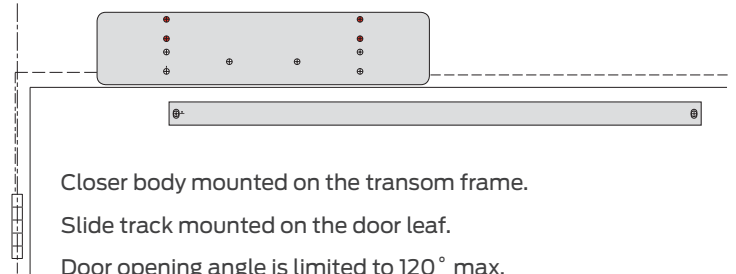
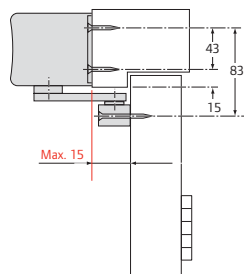

Closer body mounted on the transom frame.
 Slide track mounted on the door leaf.
 Door opening angle is limited to 120° max.

Standard closers with/without mechanical hold open (door mounted - pull side shown).

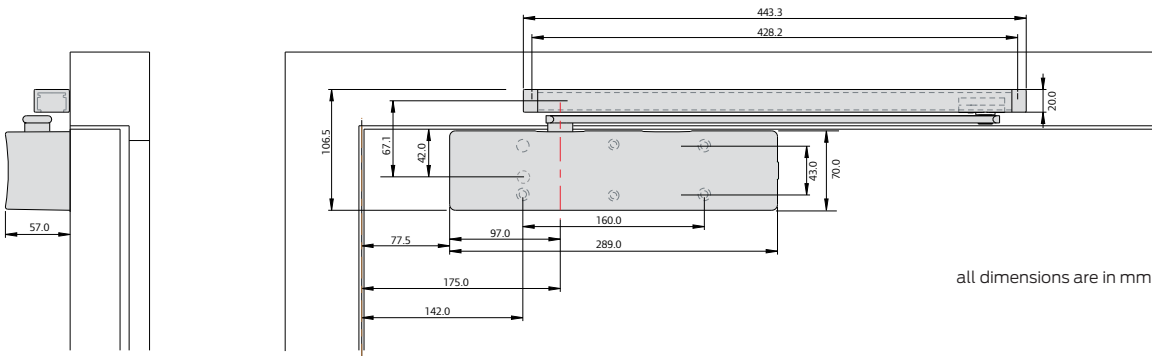

all dimensions are in mm

CISA Series D7200 - Installation options

CISA D7210

Push Side/Door Mounted

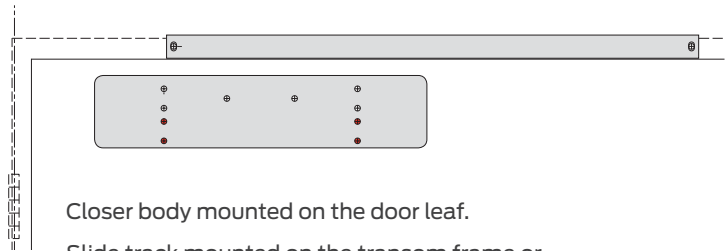
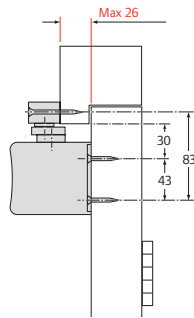

Closer body mounted on the door leaf.

Slide track mounted on the transom frame or overpanel.

Door opening angle is limited to 120° max.

CISA D7210

Pull Side/Transom Mounted

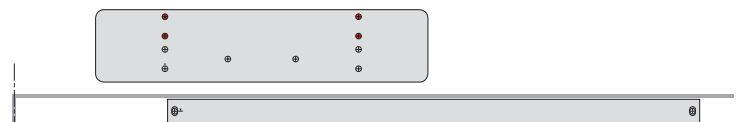
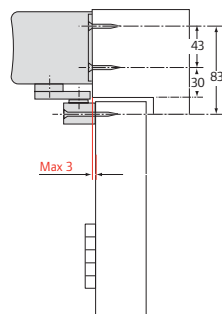

Closer body mounted on the transom frame .

Slide track mounted on the door leaf.

Door opening angle is 180° max.

CISA Series D7200 - Specifications

The CISA D7200 Series is available in 2 models:

Standard model - Overhead door closer with slide channel conforming to the requirements of EN 1154, with adjustable power sizes 2 to 5. The closer and slide track are suitable for both left and right hand applications and can be installed on the push or pull side of the door or to the transom (see page 5).

Mechanical hold-open application - Overhead door closer with slide track incorporating an adjustable mechanical hold-open device. Hold-open angle can be adjusted from 80° to 120° and allows the door to be manually released from the hold-open position with adjustable power sizes 2 to 5.

The closer and slide channel are suitable for both left and right hand applications and can be installed on the push or pull side of the door or to the transom.

Additional hold-open/conversion kit required Ref: **1.07210.00.0.**

Mechanical hold-open models must not be used on fire and smoke doors.

Finishes

The CISA D7200 Series is available with covers, arms and slide track in a selection of architectural finishes as standard.

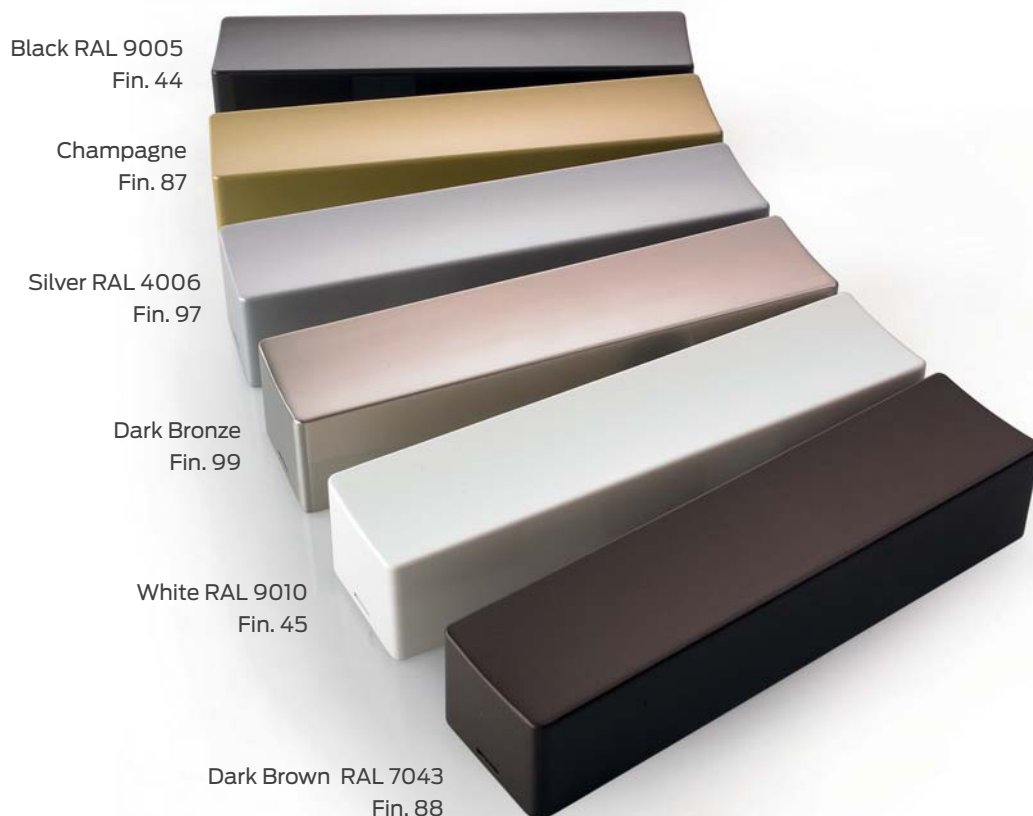

CISA Series D7200 - Specifications

Specification

The CISA D7200 Series is CE marked to EN1154 (performance) and certified to EN1634-1 (fire) and EN1155 (electromechanical hold-open variants).

- Adjustable EN power sizes 2 - 5 and 2 - 4 in transom push side mounting.
- 'FAST PowerAdjust' function – in built visible strength regulator.
- Cast iron mechanism with cam action technology.
- Unique A-Line metal all over cover in a range of finishes.
- 'Accufit' Installation self-adhesive template for quick and accurate positioning and first fix mounting plate for easy installation.
- Backcheck and delayed action as standard.
- Optional mechanical and electromagnetic hold open facility.
- Two separate models to satisfy all applications.
- 2 year guarantee.

| Product features | | Product references | | | |
|--|---------------------------------|--------------------|---------------|---------------|---------------|
| EN Closer size | max. door size [width - weight] | D7200 | D7210 | D7201 | D7211 |
| 1 | 750mm - 20kg | | | | |
| 2 | 850mm - 40kg | ■ | ■ | ■ | ■ |
| 3 | 950mm - 60kg | ■ | ■ | ■ | ■ |
| 4 | 1100mm - 80kg | ■ | ■ | ■ | ■ |
| 5 | 1250mm - 100kg | ■* | ■ | ■ | ■ |
| 6 | 1400mm - 120kg | | | | |
| Pull side door / Push side transom mounting | | ■ | | ■ | |
| Push side door / Pull side transom mounting | | | ■ | | ■ |
| Variable closing power EN size | | 2 - 5* | 2 - 5 | 2 - 5 | 2 - 5 |
| FAST power adjust | | ■ | ■ | ■ | ■ |
| Accufit template & Accufit mounting plate | | ■ | ■ | ■ | ■ |
| Maximum angle of opening (pull side) | | 180° | 180° | 120° | 120° |
| Separate closing speed & latch action adjustment | | ■ | ■ | ■ | ■ |
| Adjustable backcheck | | ■ | ■ | ■ | ■ |
| Adjustable delayed action | | ■ | ■ | ■ | ■ |
| In-built temperature compensation | | ■ | ■ | ■ | ■ |
| Mechanical hold open facility | | □ | □ | ■ | ■ |
| Matching slide channel, arm & cover finish | | ■ | ■ | ■ | ■ |
| Dimensions (body L x D x H mm) | | 289 x 57 x 70 | 289 x 57 x 70 | 289 x 57 x 70 | 289 x 57 x 70 |
| Channel/slide arm | | 443 x 20 | 443 x 20 | 443 x 20 | 443 x 20 |
| Warranty period | | 2 years | 2 years | 2 years | 2 years |

CE Classification

4 8 2-5 1 1 3

* EN 2 - 4 when push-side transom mounted



The CISA D7200 Series is type tested and independently certified for conformity to all the requirements of EN 1154 and EN 1155. They are CE marked and classified as shown in the table above.

PLEASE NOTE: Door closers fitted with a mechanical hold-open device CANNOT be CE marked.

For declaration of performance go to: www.cisa.com

CISA D6200 Series – Easy opening cam action technology in a simple, slimline package



The CISA D6200 Series incorporates the same high efficiency cam action as the CISA D7200 Series, providing the same exceptional ease of use by reducing the resistance encountered when initialising the opening of the door.

The CISA D6200 Series is offered as a simplified version of the CISA D7200 and is available with a radiused slide in trimplate.

Easy Opening, Reliable Closing

In contrast to a conventional rack and pinion door closer in a slide channel application, the linear cam action principle of the CISA D6200 Series is extremely efficient. The initial opening force decreases very rapidly as the door opens allowing, in particular, children and the elderly to overcome the closing power without any problem.

The CISA D6200 Series is CE marked to EN1154 and fire tested to EN1634 on timber doors to achieve a 2 hour fire rating.



CISA Series D6200 - Cam action

An instructional video is available on the CISAlocks channel of YouTube .



CISA D6200 closer options showing the radiused slide in trimplate which covers all the fixings and adjustment screws.



Features & Benefits

- A** CISA D6200 Series has an extruded aluminium body.
- B** High performance cam action technology is extremely efficient, allowing the closer to be set to provide reliable closing power for fire door applications yet still be easy to open.
- C** Full complement bearings provide increased bearing load for efficient operation and improved reliability.
- D** Power adjustment allows installers to adjust the spring power to suit the size and location of the door.
- E** Coil springs manufactured in silicon chrome alloy steel for superior strength and reliability.
- F** High quality hydraulic fluid with built-in temperature compensation ensures reliable performance in temperatures from -15 °C to +40 °C without the need for seasonal adjustments.
- G** A radiused slide in cover and spindle cap is available to conceal the main door closer fixings and adjustment screws.
- H** An alternative 'all-over' cover is also available, secured by simple unobtrusive spring clips and providing a smooth, contemporary look.
- I** Co-ordinated track design with concealed fixings, provides smooth operation of the opening and closing cycle.
Accufit template, together with easy-to-read instructions assist quick and easy installation.
- 0** See standard control options and adjustments 0 - 3 overleaf, adjustable by Hex socket key.
- 5** Optional mechanical hold-open facility.

CISA Series D6200 - Adjustments

Installation made quick and easy

As with the the CISA D7200, the CISA D6200 Series utilises the self adhesive template to accurately position the closer during installation.



Closer adjustments

Adjustable closing power

EN 2 - 4 power level adjustment.

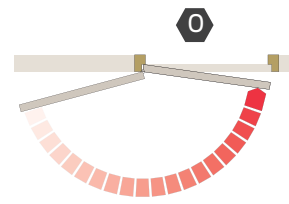

Adjustable closing speed

Adjustable from 120° opening through to the final 7°.

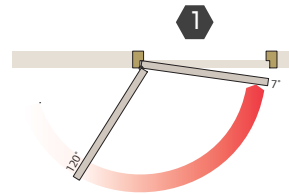

Adjustable latch action

The speed of closing in the last 7° can be adjusted to overcome seals and latches.

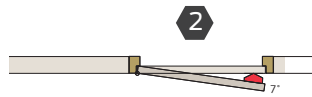

Adjustable backcheck

To prevent damage to the door, hardware and adjacent walls, caused by the door being flung open or caught by a gust of wind. The angle is adjustable between 70° and 180°.

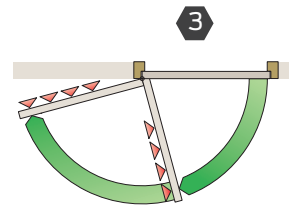

Adjustable hold-open

Mechanical hold-open variants are available to hold the door in the open position.

Mechanical hold open 80° - 120° Max.

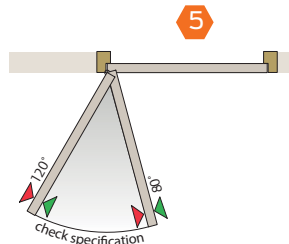

CISA Series D6200 - Installation options

CISA 1.D6200.03.0.97

Pull Side/Door Mounted

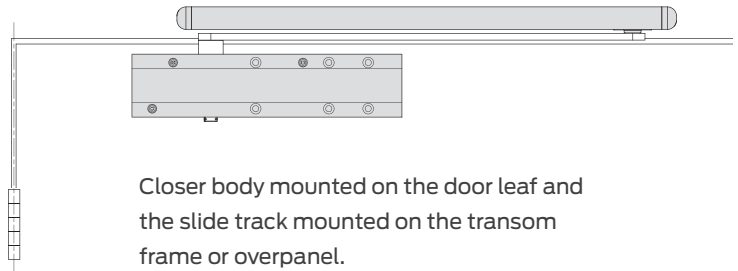
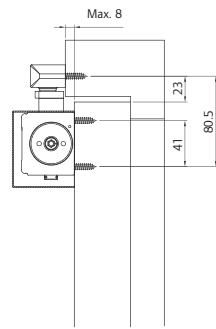

Closer body mounted on the door leaf and the slide track mounted on the transom frame or overpanel.

Door opening angle is 180° max.

CISA 1.D6200.03.0.97

Push Side/Transom Mounted

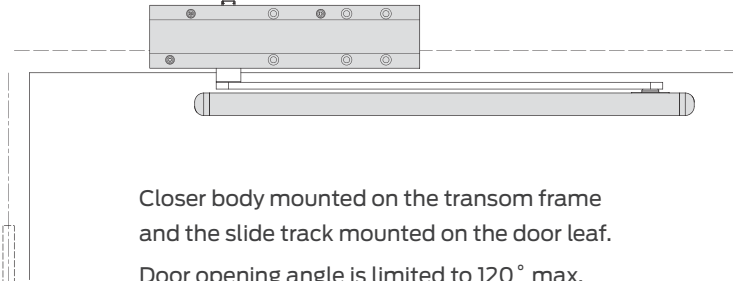
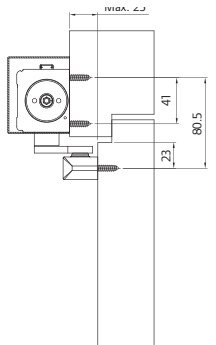

Closer body mounted on the transom frame and the slide track mounted on the door leaf.

Door opening angle is limited to 120° max.

CISA 1.D6210.03.0.97

Push Side/Door Mounted

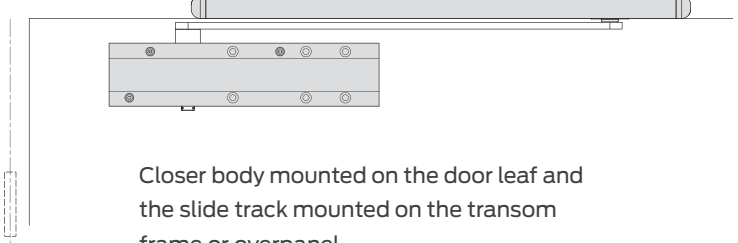
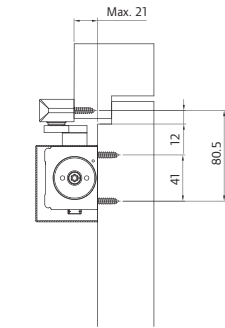

Closer body mounted on the door leaf and the slide track mounted on the transom frame or overpanel.

Door opening angle is limited to 120° max.

CISA 1.D6210.03.0.97

Pull Side/Transom Mounted

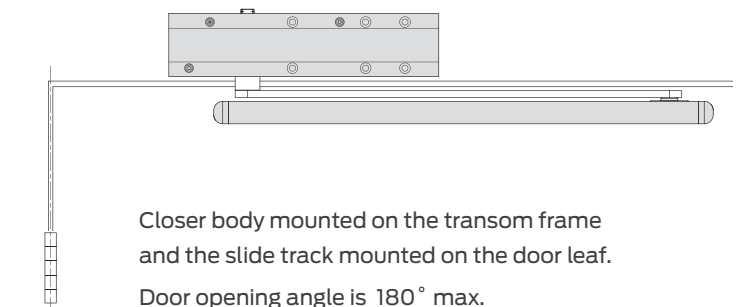
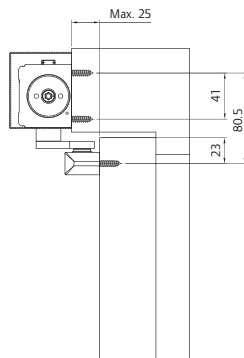

Closer body mounted on the transom frame and the slide track mounted on the door leaf.

Door opening angle is 180° max.

Closers with slide in trimplate

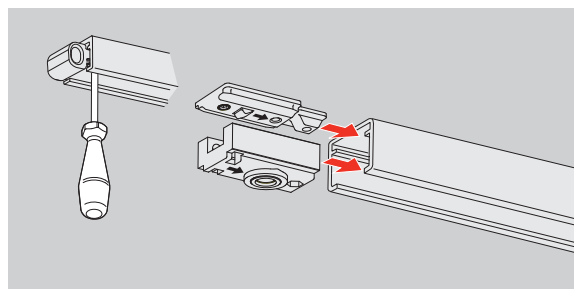
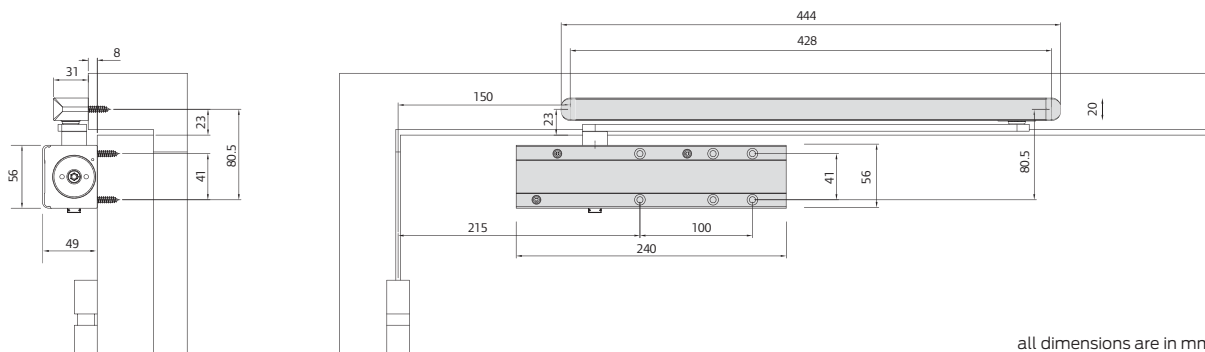

Mechanical Hold Open Unit

The hold open unit is achieved by use of a conversion kit which can be installed into the slide track of the mechanical closers in place of the standard pivot block. It enables doors to be securely held in the open position at the required pre-set angle (adjustable on installation from 80° to 120° depending on model and the mounting application).

The hold open facility can be easily switched on/off and the force required to release the hold open action can be adjusted to suit the weight of door.

Conversion Kit reference **1.07209.02.0**

Please note, mechanical hold open is not permitted on fire door applications.

Specification

The CISA D6200 Series is CE marked to EN 1154 (performance) and certified to EN 1634-1 (fire).

- Adjustable EN power sizes 2 to 4.
- CE marked.
- Power adjustment by regulator.
- Extruded aluminium body with cam action technology.
- Slide in radiused cover plate.
- Optional all-over metal cover.
- 'Accufit' Installation self-adhesive template for quick and accurate positioning.
- Adjustable backcheck as standard.
- 180° opening.
- Optional mechanical hold open facility.
- Two separate models to satisfy all applications.
- 2 year performance guarantee.

CISA Series D6200 - Specifications

The CISA D6200 Series is available in 2 models:

Standard Model - Overhead door closer with slide channel conforming to the requirements of EN 1154, with adjustable power sizes 2 to 4. The closer and slide track are suitable for both left and right hand applications. Two models are available and must be specified according to the mounting position required - installed on the push or pull side of the door or to the transom. See diagrams on page 11.

Mechanical Hold-Open Application - Overhead door closer with slide track incorporating an adjustable mechanical hold-open device. Hold-open angle can be adjusted from 80° to 120° and allows the door to be manually released from the hold-open position with adjustable power sizes 2 to 4.

Additional hold-open/conversion kit required Ref: **2320.HP**

Mechanical hold-open models must not be used on fire and smoke doors.

| Product features | | Product reference | |
|--|---------------------------------|-------------------|---------------|
| EN Closer size | max. door size [width - weight] | 1.D6200 | 1.D6210 |
| 1 | 750mm - 20kg | | |
| 2 | 850mm - 40kg | ■ | ■ |
| 3 | 950mm - 60kg | ■ | ■ |
| 4 | 1100mm - 80kg | ■ | ■ |
| 5 | 1250mm - 100kg | | |
| 6 | 1400mm - 120kg | | |
| Pull side door / Push side transom mounting | | ■ | |
| Push side door / Pull side transom mounting | | | ■ |
| Variable closing power EN size | | 2 - 4 | 2 - 4 |
| Accufit template and Accufit mounting plate | | ■ | ■ |
| Maximum angle of opening* | | 180° | 180° |
| Separate closing speed & latch action adjustment | | ■ | ■ |
| Adjustable backcheck | | ■ | ■ |
| Adjustable delayed action | | | |
| In-built temperature compensation | | ■ | ■ |
| Mechanical hold-open | | □ | □ |
| Matching slide channel, arm & cover finish | | ■ | ■ |
| Dimensions (with trimplate L x D x H mm) | | 240 x 56 x 49 | 240 x 56 x 49 |
| Channel/slide arm | | 444 x 20 | 444 x 20 |
| Warranty period | | 2 years | 2 years |
| CE classification | | 4 8 2-4 1 1 3 | |

■ Standard

□ Optional

* When door mounted.

Transom mounted closers are restricted to 120° opening.

The CISA D6200 Series is available in the following standard finishes.



Black
RAL 9005
Fin. 44



Champagne
-
Fin. 87



Argento
RAL 9006
Fin. 97



Bianco
RAL 9010
Fin. 45



Testa di moro
RAL 7043
Fin. 88

For declaration of performance go to: www.cisa.com

CISA D8200 Series - Cam action in a compact concealed overhead closer



Versatile and elegant

The CISA D8200 Series is a precision manufactured cam-action, slide channel door closer, in a compact concealed unit. With the closer body mounted within the top of the door and the slide track within the head frame, the CISA D8200 Series offers high resistance to abuse and offers a highly aesthetic solution being fully concealed when the door is closed. Suitable for doors 44mm thick and above.

Providing exceptional ease of use by reducing the resistance encountered when opening the door, the CISA D8200 Series bridges the gap between the requirements for fire and smoke control and ease of operation required for accessibility.

The CISA D8200 Series is CE marked to EN1154 and fire tested to EN1634-1 on timber doors to achieve a 1 hour fire rating when installed with the approved intumescent gasket set (1.07209.20.0).



CISA Series D8200 - Cam action



Features & Benefits

- A** CISA D8200 Series has a compact extruded aluminium body requiring minimal removal of material from the door and frame.
- B** High performance cam action technology is extremely efficient, allowing the closer to be set to provide reliable closing power for fire door applications yet still be easy to open.
- C** Needle roller bearings provide increased bearing load for efficient operation and improved reliability.
- D** Power adjustment allows installers to adjust the spring power to suit the size and location of the door.
- E** Coil springs manufactured in silicon chrome alloy steel for superior strength and reliability.
- F** High quality hydraulic fluid with built-in temperature compensation ensures reliable performance in temperatures from -15 °C to +40 °C without the need for seasonal adjustments.
- G** Aluminium slide track 23mm wide.
- H** Powder coated steel track arm with nylon runner.
- I** Ideally suited to factory preparation of the door and frame.
CISA D8200 Series door controls are packed complete - reducing the possibility of lost or missing parts.
Non handed design is suitable for all applications and has a maximum opening angle of 120 °.
- O** See standard control options and adjustments
0 - 2 overleaf, adjustable by Hex socket key.
- 4** Optional cushion stop (ref: **1.07209.010**) helps prevent doors from coming into contact with adjacent walls (note: this is not a backcheck function).
- 5** Optional mechanical hold-open unit can be retrofitted into the slide track.

CISA Series D8200 - Adjustment

Installation

For all overhead door closers to function efficiently, accurate and correct installation is required. This will not only enable the closer to perform to its designed specification but will provide extended life cycles.

The concealed CISA D8200 Series closer benefits particularly from factory preparation of the door and frame. This minimises the amount of material removed from the door, an essential aspect in fire door applications in particular.



Intumescent gasket set (107209.20.0)

A significant amount of fire resisting doorset material is removed when concealed closers are mortised into the door leaf. The intumescent gasket set will provide the additional performance that is required to protect the door from integrity failure during fire conditions.

It is particularly important with these closers to check that the details of the fire test certification are relevant to your intended door application.

Closer adjustments

Adjustable Closing Power

EN 2 - 4 power level adjustment.

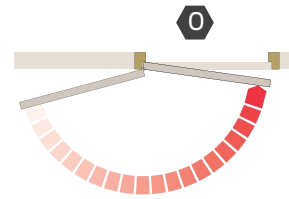

Adjustable Closing Speed

Adjustable from 120° opening through to the final 7°.

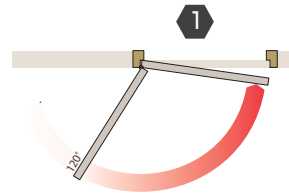

Adjustable Latch Action

The speed of closing in the last 7° can be adjusted to overcome seals and latches.

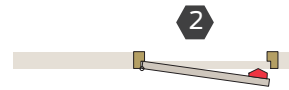

Adjustable Hold-Open

Mechanical hold-open option is available to hold the door in the open position (see below).

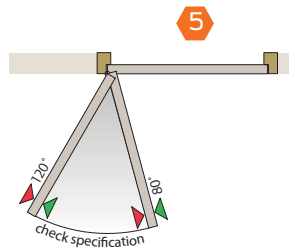

Mechanical Hold Open Unit

The hold open unit is achieved by use of a conversion kit which can be installed into the slide track of the mechanical closers in place of the standard pivot block. It enables doors to be securely held in the open position at the required pre-set angle (adjustable on installation from 80° to 120° depending on model and the mounting application).

The hold open facility can be easily released.

Conversion Kit reference **1.07209.000**

Please note, mechanical hold open is not permitted on fire door applications.

CISA Series D8200 - Opzioni di installazione

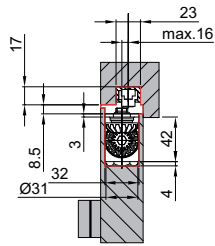

Door Mounted

With the closer body mounted in the top of the door leaf and the slide track in the underside of the transom or head frame.

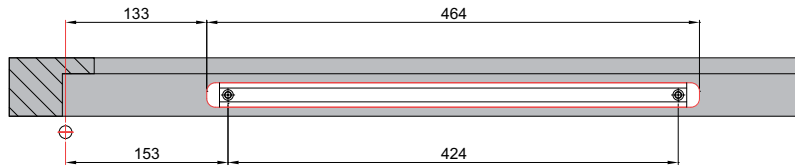
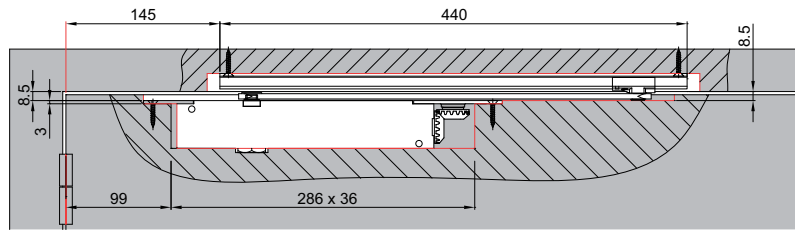

view of underside of transom

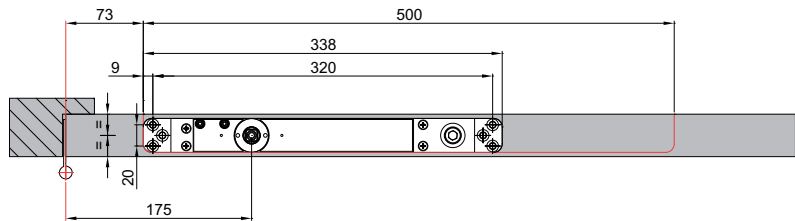

view of top of door leaf

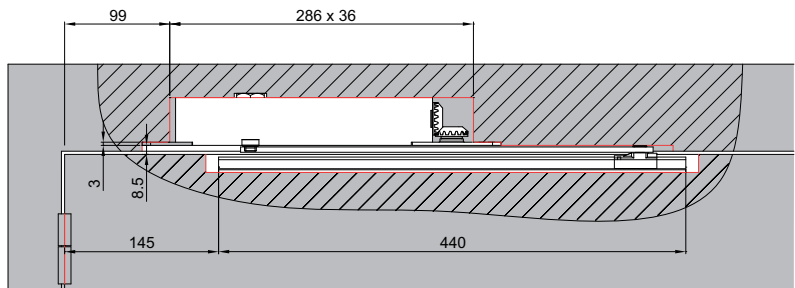
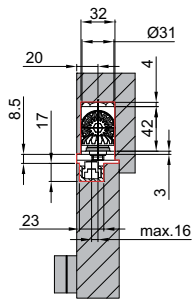

Transom Mounted

With the closer body mounted in the underside of the transom and the slide track in the top of the door.

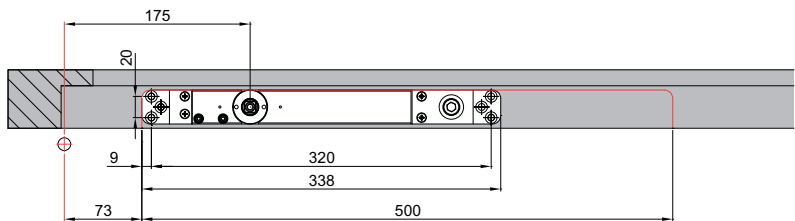

view of underside of transom

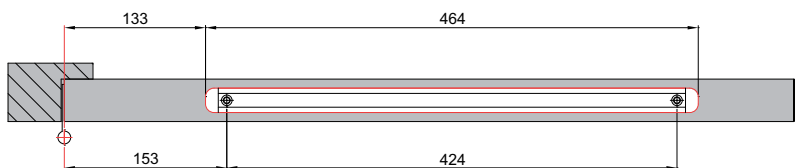

view of top of door leaf

CISA Series D8200 - Specification

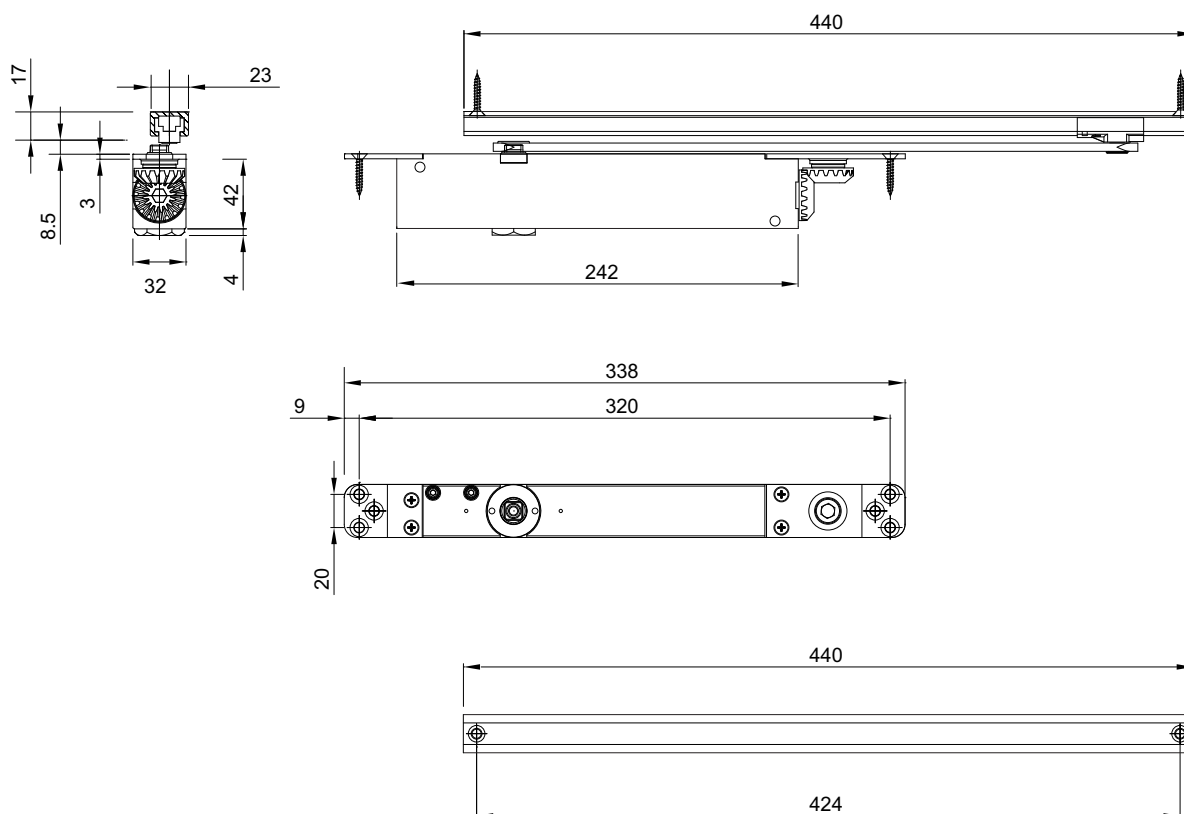

Tutte le dimensioni sono espresse in mm

Specification

The CISA D8200 Series is CE marked to EN 1154 (performance) and certified to EN 1634-1 (fire).

- Concealed door closer to EN 1154.
- Adjustable EN power sizes 2 to 4.
- CE marked.
- Extruded aluminium body with cam action technology.
- Power adjustment by regulator.
- Adjustable closing speed and latch action.
- Optional cushioning stop (Ref: **1.07209.010**).
- Slimline aluminium slide track.
- 10 year performance guarantee.

For declaration of performance go to:

www.cisa.com

| Product features | | Product reference |
|--|---------------------------------|----------------------|
| EN Closer size | max. door size [width - weight] | 1.D8200 |
| 1 | 750mm - 20kg | |
| 2 | 850mm - 40kg | ■ |
| 3 | 950mm - 60kg | ■ |
| 4 | 1100mm - 80kg | ■ |
| 5 | 1250mm - 100kg | |
| 6 | 1400mm - 120kg | |
| CE marked and EN 1154 compliant | | ■ |
| Variable closing power EN size | | 2 - 4 |
| Min. door thickness for FD30 doors | | 44mm |
| Max. angle of opening | | 120° |
| Separate closing speed & latch action adjustment | | ■ |
| Adjustable backcheck | | |
| In-built temperature compensation | | ■ |
| Cushion stop | | □ |
| Hold open facility | | □ |
| Arm & track finish | | Silver, SS or PS |
| Dimensions (L x D x H mm) | | 242 x 42 x 32 |
| Channel/slide arm | | 440 x 17 |
| Warranty period | | 2 year |
| CE Classification | | 3 8 2-4 1 1 3 |

- Standard
- Su richiesta

Access For All

Improved accessibility in and around a building is becoming an increasing requirement in many environments. For some building users a self-closing fire door can become a barrier – or at least an obstacle. Many countries are introducing laws or building regulations to ensure building owners take reasonable measures to avoid this situation. The CISA Cam action door closer helps the building owner meet their responsibilities and enhances user experience.



Maintenance

Door closers are crucial to the safety of a building and its occupants and consequently the correct operation of the door should be checked regularly against the effects of wear & tear and abuse.

- Only non corrosive and non abrasive cleaning agents should be used.
- Check all fixings are secure and make a visual check for faults and wear.
- Check the correct functioning of the door; that the door closes properly into the frame and the latch, if fitted, secures the door firmly in position.
- Make any adjustments as necessary for closing power/closing speed and latch action.
- Lubricate all external moving parts on the arm and pivot linkage.
- Ensure the closer is clean and free from all debris.
- For electromagnetic hold open closers ensure the system is operating correctly by using the test button located on the underside of the track.

CISA S.p.A. reserves the right to make any changes to products illustrated in this catalogue without prior notice. All measurements are in millimetres.

About Allegion

Allegion (NYSE: ALLE) creates peace of mind by pioneering safety and security. As a \$2 billion provider of security solutions for homes and businesses, Allegion employs more than 7,800 people and sells products in more than 120 countries across the world. Allegion comprises 23 global brands, including strategic brands CISA®, Interflex®, LCN®, Schlage® and Von Duprin®.

For more, visit allegion.com



CISA SpA
Via Oberdan 42
48018 Faenza (RA) Italy
Tel +39 0546 677111
Fax +39 0546 677150
cisa.vendite@allegion.com
cisa.com
cisahotels.com

@cisalocks



ALLEGION™